

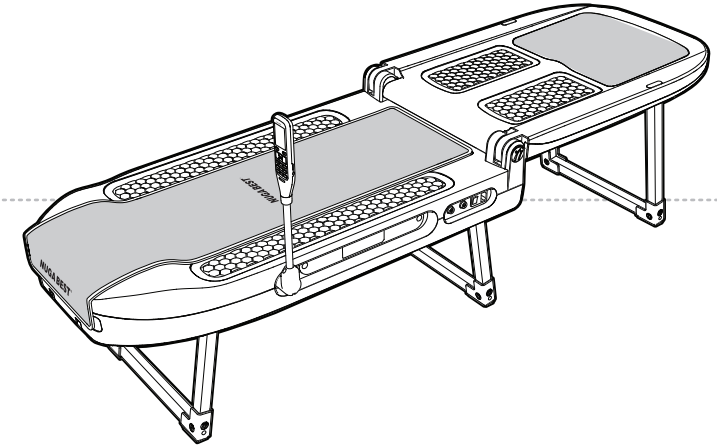

CE

NUGA
www.nuga.kr

[ENGLISH]



 **NUGA MEDICAL CO.,LTD.**

 185, Jiraeul-ro, Jijeong-myeon, Wonju-si,
Gangwon-do, Korea
TEL : +82-33-730-0001 / FAX : +82-33-730-0007

<http://www.nuga.kr>

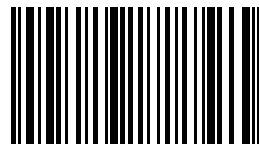

160850000507

ENGLISH / CE H/H / A TYPE / Rev. 02
2017.01.20

N5



User Manual

Thank you for purchasing this product.
Before use...
Please read the cautions for safety in the
user manual to use this product safely.

Quality Warranty Enclosed

Tourmanium and NDT applied device

 **NUGA MEDICAL CO.,LTD.**

Product Introduction

Product features	8
Guide and Sequence for Product Installation	9
Names and Functions of Product	10
Product Components	12

Production Installation and Use

Before the Product Installation	14
How to Install the Product	16
Test Operations after Installation	18

How to Use the Product

Descriptions for Controller Buttons	20
Display setup	21
How to Use the Controller	22
How to Use the Product by Mode	22
Temperature setting for the Auxiliary heating part	25
How to Use the Low Frequency Pad	26
How to Use the external projector	28
Preheating function	29
Sleep music	30
How to Use the Product	32

Product Storage and Care

How to Store and Clean the Product after Use	34
Check Indicator Window of Controller	35
How to Take Emergency Actions during Use	36
Self-check Items	37
Before any A/S Request	38
Product Specifications	39

Cautions for your safety

- These cautions include descriptions for the safety of users and prevention of any damage to properties among others.
- Read through the following details to use the product appropriately.
- This Manual classifies the risk level into following three degrees and the following graphical symbols remind users of cautions for matters and operations of concerns about any risk.

Interpretations on symbols



Danger

If there is high possibility of death due to non-compliance.



Warning

If there is a possibility of an injury or death due to non-compliance.



Caution

If there is a possibility of a minor injury or damage to goods due to non-compliance.

Disclaimer

- The manufacturer, importer and/or agent shall not be responsible for any problem and/or other damage to the product which has been caused from the user's fault or operation.
- Information in the user manual has been prepared on the basis of the current product specifications.
- Details in the user manual might be different from those on the product.
- The product manufacturer will be adding and supplementing new functions at any time and new technologies shall be applied to the product continuously in the future as well.
- All the standards and functions are subject to change without any notice to users to improve performance.

Danger



Put the external projector cover on the external projector while using the external projector to keep the projector from touching the skin directly.
(Otherwise, it is likely that injuries occur.)

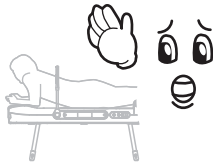

When using the device while lying down on your stomach, do not use it on your ribs and use it only on the abdomen in manual mode.



Avoid applying the external projector directly to eyeballs to prevent any risk.
(Otherwise, it might cause damage to eyeballs.)

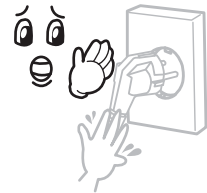

Avoid pulling out the power cord parts or touching the power plug with the wet hands.
(Otherwise, it might cause electrical shock or fire.)

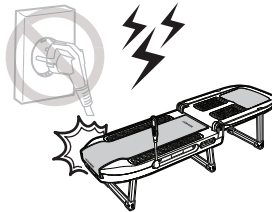

Immediately stop using the product and turn off the power if there is any thunder, lightning or earthquake.
(Otherwise, it might cause electrical shock or fire.)

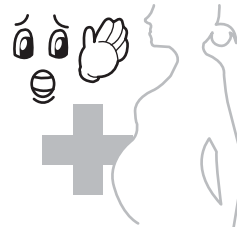

Any persons meeting the following criteria shall not use this device. This device should not be used by a pregnant woman or a patient with a chronic disease, malignant tumor, high fever, heart disease (pacemaker implant), perceptual disorder, skin problem in the target area, or spondylolysis



Avoid using the product in a closed place in presence of any fuel and/or chemical.
(Otherwise, it might cause injuries or fire.)

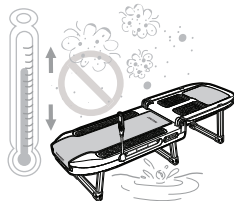

Do not use the device in areas that are dusty or have severe temperature fluctuations or where it can come into contact with water.
(There are risks of electric shock and fire.)

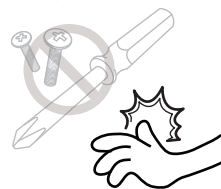

Anyone other than technicians qualified for our company's A/S should not disassemble, repair or modify the product for any reason.
(Otherwise, it might cause damage to the product or electric shock and/or fire.)

Warning

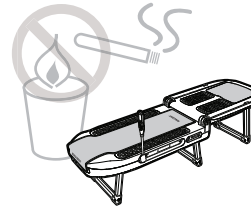

Avoid placing inflammable substances like candlelight, cigarette light or liquors and/or vessels containing water, heavy objects or other objects on the product.
(Otherwise, it might cause fire.)

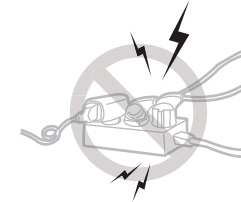

Do not insert many power plugs for other products into a socket to be used simultaneously.
(Otherwise, it might cause electric shock, injury and/or damage to the product.)

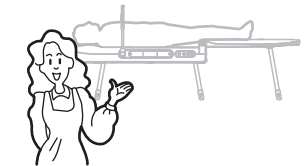

Avoid twisting the body while the internal projector is being operated.
(Otherwise, it might cause excessive influences to the spine.)

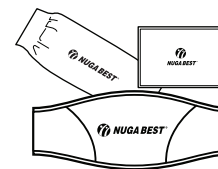

Avoid using any band or belt that does not come as one of components from the purchase of the product.
(Otherwise, it might cause damage to the product.)



Apply the product to the area with any surgery and/or treatment, after consulting with the store or the company from which you have purchased the product.

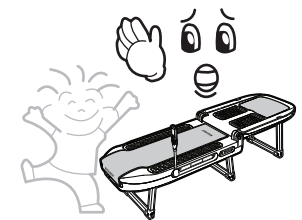

Do not allow children use the product alone.

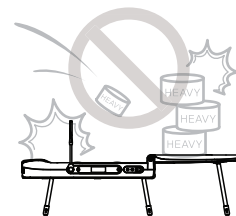

Avoid jumping on the product or any other action to provide shocks to the product.
(Otherwise, it might cause injuries and/or damage to the product.)



Use the product after checking out any damaged or worn-out cord.
(Otherwise, it might cause electric shock, injury and/or damage to the product.)

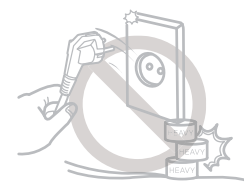

Avoid bending the power cord excessively or pressing it down with heavy objects.

⚠ Caution

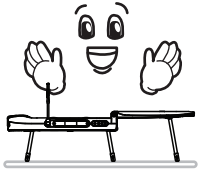

Install the product horizontally.



Please abide by defined time and methods.

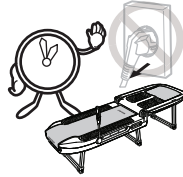

Separate the power cord while the product is not being in use for a long time.

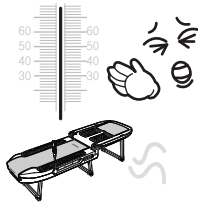

Use the product in a range of proper temperature as there is risk of burns if the higher temperature is set.
Do not use directly on skin.
The appliance has a hot surface. Persons insensitive to heat must be careful when using the appliance.

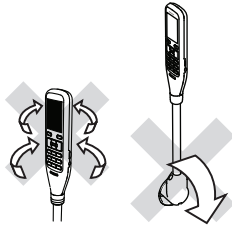

Do not bend or rotate the controller by force as it may cause damage or failure.



Be aware of danger of falling down when you get on or off the product.

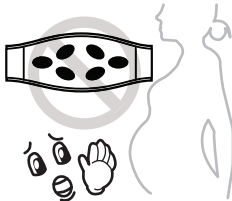

Any pregnant women shall not use the low frequency pad.

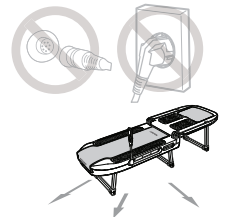

Move the product after separating the power supply from connecting lines when if the product is moved.



Check out the applied voltage before any use and apply the power plug only to a dedicated socket.

N5

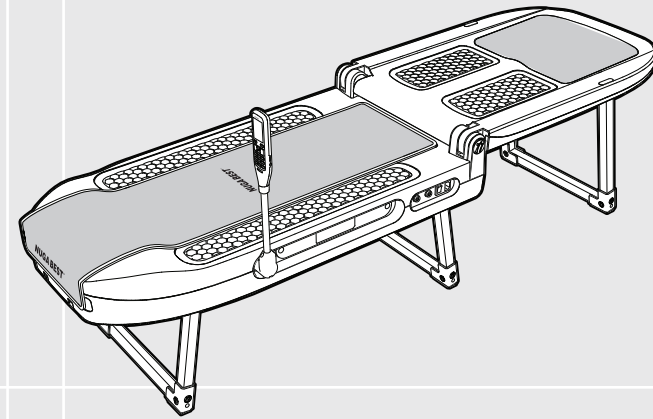

Product Introduction

Product features	8
Guide and Sequence for Product Installation	9
Names and Functions of Product	10
Product Components	12

Sophisticated Design

The ergonomic design ensures comfort during use. Beautiful materials with good tactile impression in high quality are applied. The brown color appears elegant and calming.

Convenient foldable structure

It can be folded in half, which facilitates storage under the bed or in confined spaces. It is equipped with wheels, making it easier to move.

Internal Projector Designed in Human Engineering

The internal projector is designed to move in all four directions at a pre-set angle, which ensures that the acupressure is applied uniformly all over the body. It is equipped with a separate element for the cervical vertebral region.

Conveniently Designed External projector

External projector is designed in a size conveniently held and used with a hand, which can be stored in a basket nicely during no use.

Internal Driving Method with Noise Reduction

There are few noises thanks to the minimized friction between the internal projector and rail due to the specially designed guard rail which can be used semi-permanently by minimizing the driving load.

Convenient Controller Holder

90° rotation and storage is made possible to prevent damage to the controller. The user can change the angle to his or her desire.

Multifunctional Controller Integrated into One

It is equipped with a liquid crystal display (LCD) for more convenient use, and the user can feel at ease, listening to soothing music through the high-quality speaker.

Auxiliary Heating Part and Tourmanium Mat

There is a Tourmanium mat in the auxiliary heating part.

1 How to refer to cautions for safety

Refer to cautions to be kept during the product use. (Refer to Page 3 in this User Manual for more details.)



4 How to Use the Controller

(Refer to Page 22 in this User Manual for more details.)



2 How to check out the product components

(Refer to Page 12 in this User Manual for more details.)



5 How to use the product

(Refer to Page 32 in this User Manual for more details.)

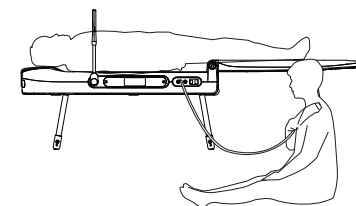
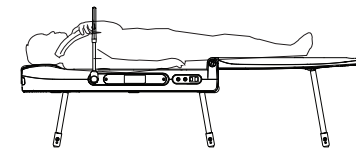

3 How to Install the Product

(Refer to Page 16 in this User Manual for more details.)

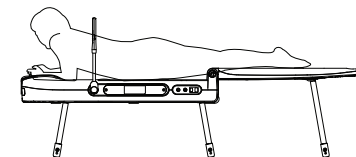
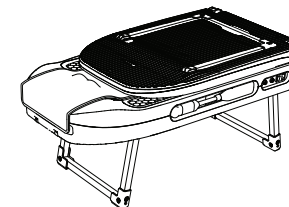

Names and Functions of Product

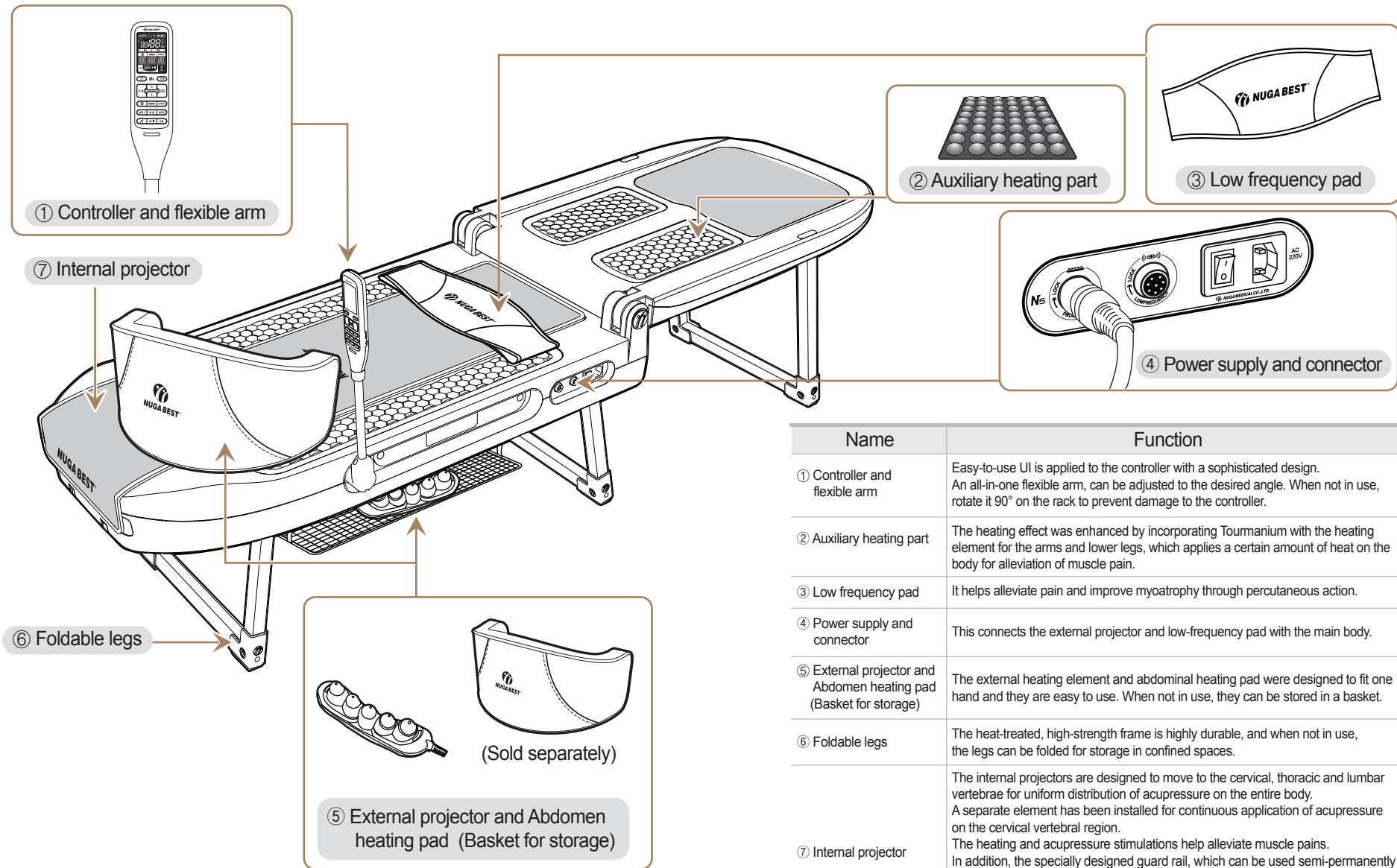

Name	Function
① Controller and flexible arm	Easy-to-use UI is applied to the controller with a sophisticated design. An all-in-one flexible arm, can be adjusted to the desired angle. When not in use, rotate it 90° on the rack to prevent damage to the controller.
② Auxiliary heating part	The heating effect was enhanced by incorporating Tourmanium with the heating element for the arms and lower legs, which applies a certain amount of heat on the body for alleviation of muscle pain.
③ Low frequency pad	It helps alleviate pain and improve myoatrophy through percutaneous action.
④ Power supply and connector	This connects the external projector and low-frequency pad with the main body.
⑤ External projector and Abdomen heating pad (Basket for storage)	The external heating element and abdominal heating pad were designed to fit one hand and they are easy to use. When not in use, they can be stored in a basket.
⑥ Foldable legs	The heat-treated, high-strength frame is highly durable, and when not in use, the legs can be folded for storage in confined spaces.
⑦ Internal projector	The internal projectors are designed to move to the cervical, thoracic and lumbar vertebrae for uniform distribution of acupressure on the entire body. A separate element has been installed for continuous application of acupressure on the cervical vertebral region. The heating and acupressure stimulations help alleviate muscle pains. In addition, the specially designed guard rail, which can be used semi-permanently by minimizing the driving load, minimizes friction between the internal projector and rail. Therefore, there are only few noises.

Product Components

i Introduction

Please check out whether there are all the components before installing the product. Please inquire from your supplier if there is any missing or damaged component. Some specifications and/or designs are subject to change for improving the product performance.

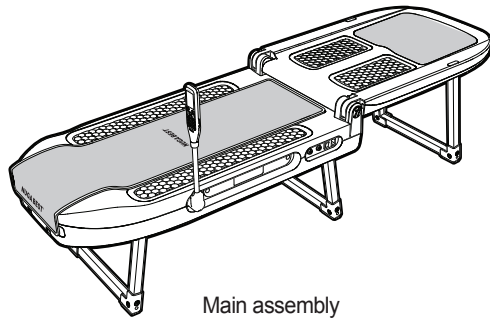

Main assembly

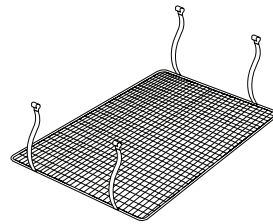

Basket

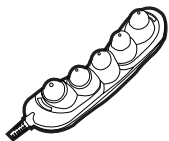

External projector



Abdomen heating pad
(Sold separately)



Low frequency pad

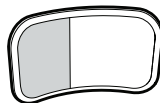

Extension band



Towel for
low frequency pad



Projector cover



Outside cover

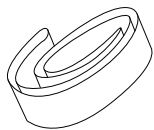

Band for storage



Power cord



User manual

N5

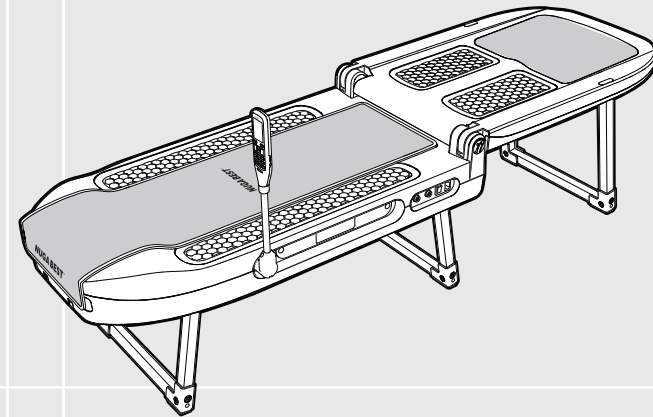

Production Installation and Use

Before the Product Installation	14
How to Install the Product	16
Test Operations after Installation	18

Before the Product Installation

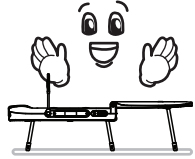

Install the product at a flat floor.
(Otherwise, it might damage the product.)

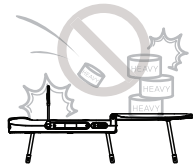

Do not drop or shock the product.
(Otherwise, it might damage the product.)

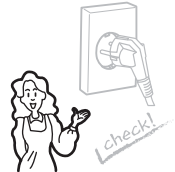

Check out the applied voltage before any use.
(Otherwise, it is likely that the electrical shock or fire occurs.)

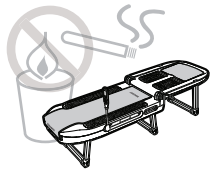

Do not place any inflammable substance on the product,
such as candlelight or cigarette light.
(Otherwise, it is likely to cause the electrical shock or fire.)

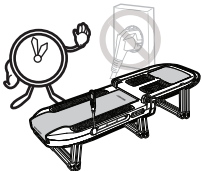

Turn off the power switch during no use for a long time.
(Otherwise, it is likely to cause fire.)

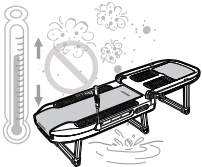

Do not use the device in areas that are dusty or have
severe temperature fluctuations or where it can come
into contact with water.
(There are risks of electric shock and fire.)

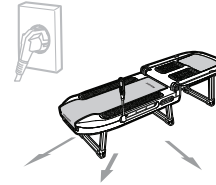

Move the product after separating the power supply from
connecting lines if the product is moved.
(Otherwise, it might cause electric shock, injury and/or
damage to the product.)



Do not forcibly turn the controller.
(Otherwise, it might cause damage to the product.)

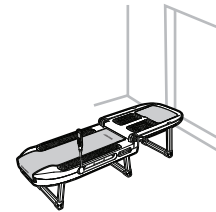

Do not install the product in a place with the frequent
access.
(Otherwise, the product might be damaged.)

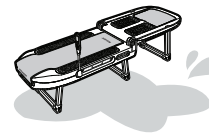

Do not install the product in a place with much moisture
or water.
(Otherwise, the product might be damaged.)

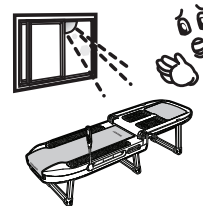

Be careful not to expose the product to the direct sunlight.
(Otherwise, the product might be damaged.)

How to Install the Product



1 Transporting the device

Transport the device using the installed wheels.

⚠ Caution

Use the band when moving it vertically or during storage.

2 Product installation

- ① Remove the band and raise the device vertically with the controller on top.
- ② Press the lever for the legs and unfold the legs.
- ③ Raise the main part of the device upright and open up the auxiliary part.
- ④ Press the hinge on the controller and rotate it 90°.
(The length can be adjusted for your convenience.)

⚠ Caution

Make sure the controller is facing up.
(The length can be adjusted for your convenience.)

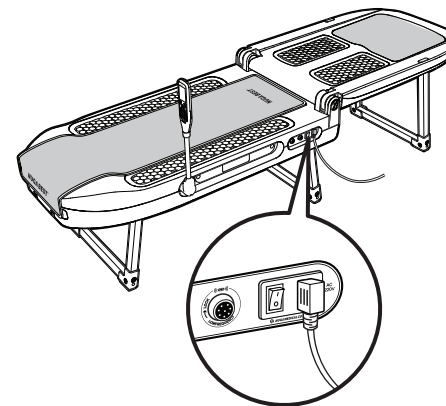
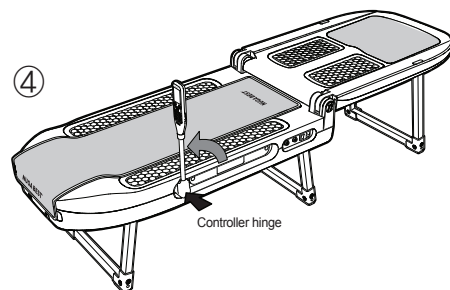
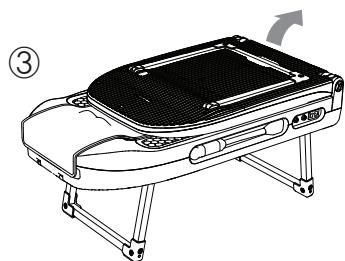
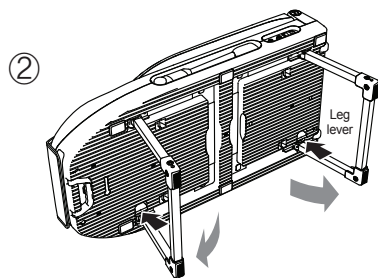
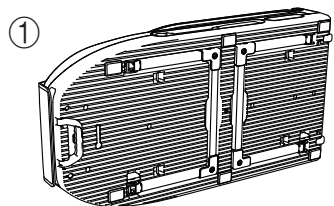

3 Turn on the power supply in the product

Connect the power cable to the body as shown in the figure and turn on the power switch.

⚠ Caution

Turn off the power switch when the power is connected. Otherwise, it might cause failure.

4 Turning on the controller

Press the  button to turn on the power and use the device. (Refer to "How to use the controller" for more details)

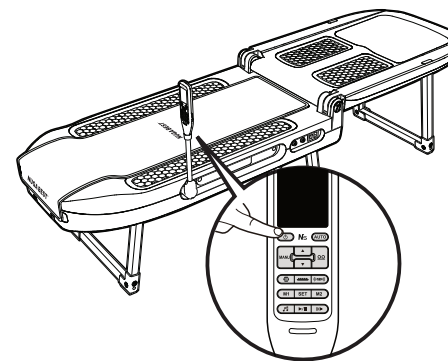

Test Operations after Installation

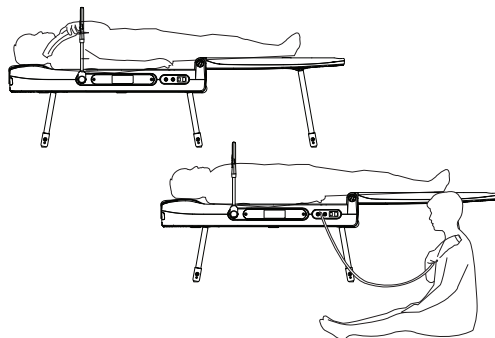
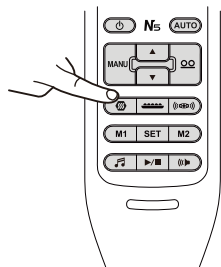
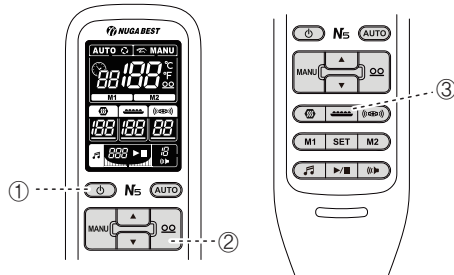
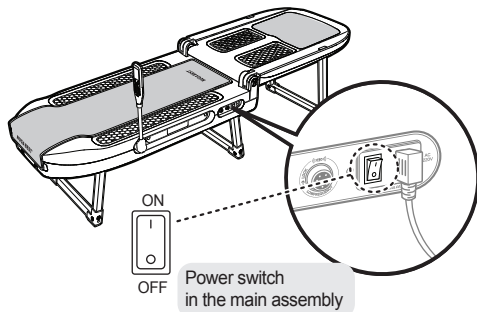

1 Check out the power supply for the product

Turn on the power switch.

⚠ Caution

Ensure the power supply to be turned off after use or during no use. Otherwise, it might cause failure.

2 Check out operations of controller

- ① Press the power button on the controller ()
- ② Adjust temperature for the internal projector (→)
- ③ Adjust temperature for the external projector (→)
Adjust temperature for the abdomen heating pad

Refer to 'How to Use the controller by Mode' (Page 22)

3 Checking out the operation of the Auxiliary heating part

Press the star () button on the controller and set the temperature by pressing or .

4 Use the product

Lie down with your legs facing the auxiliary body and press "AUTO" on the controller to operate the device in automatic mode.

N5

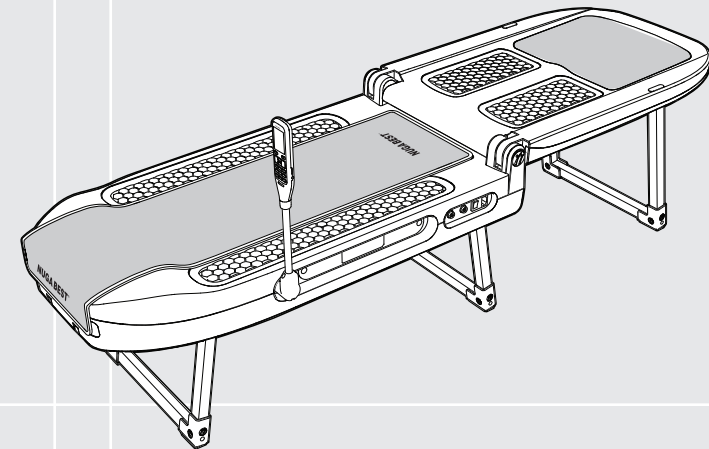

How to Use the Product

Descriptions for Controller Buttons	20
Display setup	21
How to Use the Controller	22
How to Use the Product by Mode	22
Temperature setting for the Auxiliary heating part	25
How to Use the Low Frequency Pad	26
How to Use the external projector	28
Preheating function	29
Sleep music	30
How to Use the Product	32

Controller keys

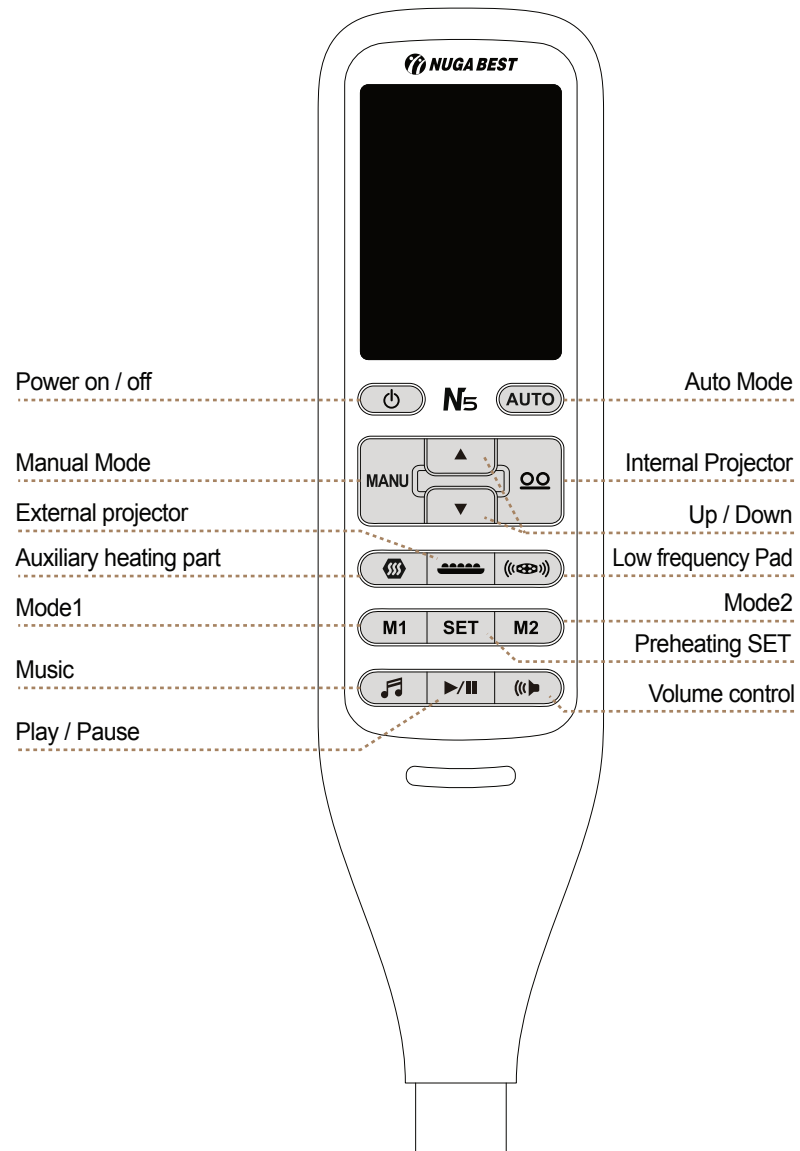

Controller display setup

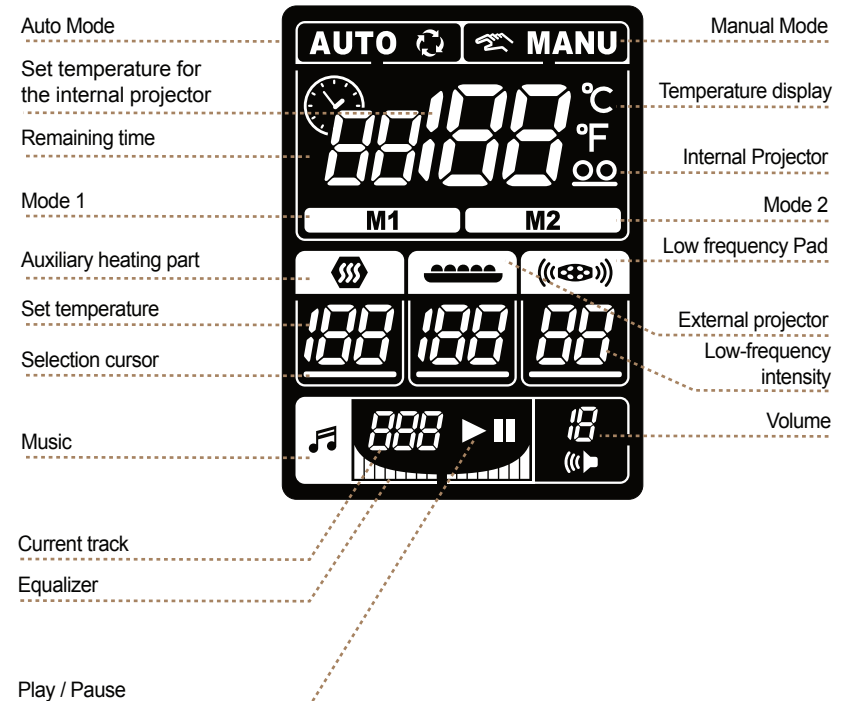

How to Use the Controller

- How to Use the Product by Mode

Auto I Mode

Massaging and steaming functions

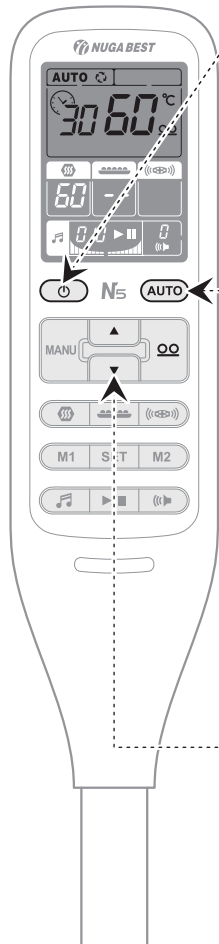

Power supply

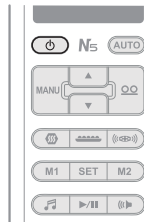

① Press the power button.

· Press the power button once : On
Press it once again : Off

Auto I Mode

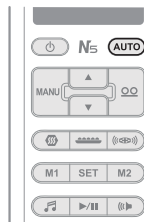

② After pressing M1 or M2 button to select time, pressing the AUTO button causes the AUTO icon to be turned on and start the automatic massage.

No separate operation is necessary in the middle as the product stops automatically after operations.

(M1 : Approximately 32 min., M2 : 47 min., and the remaining time will be displayed as a number)

Temperature control

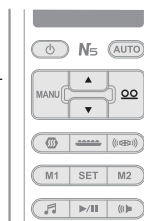

③ Press the internal projector (OO) button and adjust the temperature by pressing ▲ or ▼.
(Moderate temperature: 55~60°C)

· Range of temperature setting for internal projector: 40~70°C
(The temperature of the projector for the cervical vertebrae is fixed at 50°C.)
· Temperature setting unit
40~70°C: Temperature setting per 1°C

Auto II Mode

Round-trip massage function



Power supply

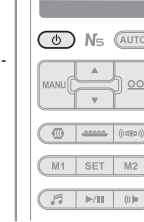

① Press the power button.

· Press the power button once : On
Press it once again : Off

Auto II Mode

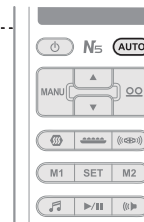

② After pressing M1 or M2 button to select time, pressing the AUTO button twice in a row causes the AUTO icon to blink and start the automatic round-trip massage.

(M1 : Approximately 32 min., M2 : 47 min., and the remaining time will be displayed as a number)

Press the AUTO button to operate AUTO II Mode during AUTO I Mode is operating.

③ In the AUTO 2 mode, the internal projector performs the massage without stopping.

How to Use the Controller

- Temperature setting for the Auxiliary heating part

Manual Mode

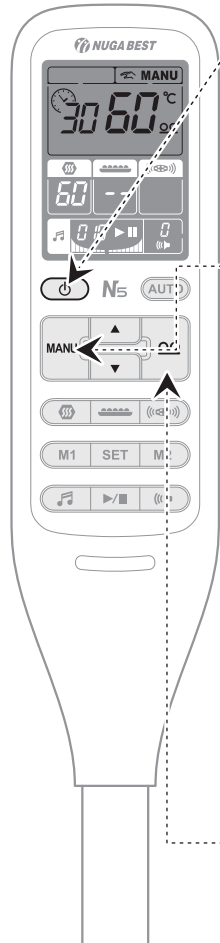

Power supply

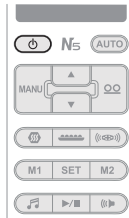

① Press the power button.

- Press the power button once : On
- Press it once again : Off

Manual Mode

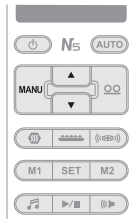

② Pressing MANU (▲, ▼) in the MANU mode will cause the MANU icon to blink and the internal projector can be moved to a desired area. The internal projector moves while (▲/▼) is being pressed.

- ▲ : The internal projector moves to the cervical and lumbar vertebrae.
- ▼ : The internal projector moves to the thoracic vertebrae region.

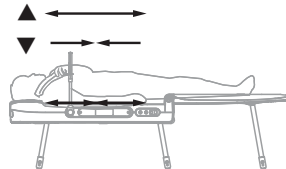

Temperature control

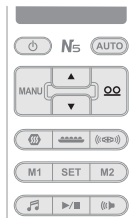

③ Press the internal projector (OO) button and adjust the temperature by pressing ▲ or ▼.
(Moderate temperature: 55~60°C)

- Range of temperature setting for internal projector: 40~70°C
- Temperature setting unit 40~70°C: Temperature setting per 1°C

The power will turn off automatically after approx. 8 hours.

Operations

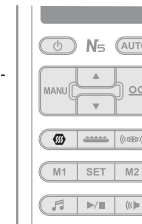

① Press the auxiliary heating part (☄) button.

- Press the auxiliary heating part button once: Select
- Press the auxiliary heating part button and hold: On/Off



When the cursor turns on, you can adjust the temperature.

Temperature control

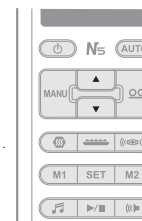

② Press the auxiliary heating part (☄) button and adjust the temperature by pressing ▲ or ▼.
(Moderate temperature: 55~60°C)

- The temperature increases until it reaches the set temperature.
- Temperature setting unit 30~60°C: Temperature setting per 1°C

The power will turn off automatically after approx. 8 hours.

How to Use the Controller

- How to Use the Low Frequency Pad

Connection



What is the low frequency pad?

The low frequency pad is a device to improve pain or amyotrophia percutaneously by applying weak current to the human body.

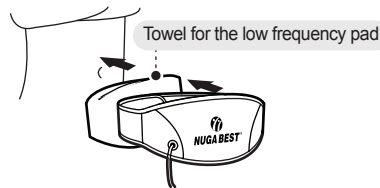

Towel for the low frequency pad

- ① If there is no get at home, place the wet low frequency pad towel or a piece of 100% cotton towel or cloth on abdomen and wear the low frequency pad.

· When you wet a towel or a cloth with water, please squeez out completely from flowing water.



Surface to contract the abdomen



- ② Wear the abdominal band after fixing the low frequency pad in a good manner.

Various wearing methods

You may wear it around any area other than the abdominal area.



Low frequency pads can be used for the users with waist size of 26-42 inches. (With the extension band, it can be used up to the waist size of 47 inches. Please inquire if it is used for more than 47nches.)

Power supply

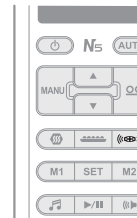

- ③ When the power is off, press the low frequency pad button (⏏) to turn it on. (By default, it is set at '00')

· Check out the connecting conditions of the low frequency pad. (In case there is no proper connection, '- -' will show on the display)

Intensity control

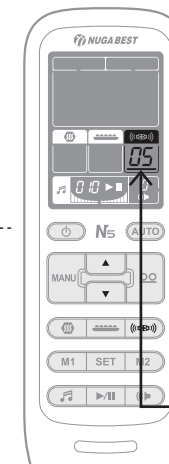

- ④ Press the low-frequency pad (⏏) button and adjust the intensity by pressing ▲ or ▼.

(The intensity can be adjusted within the range of 0 to 20. It will automatically turn off when it is not in contact with a human body.)

When the cursor turns on, you can adjust the intensity.

The low frequency pad automatically stops after operations for about 40 minutes.

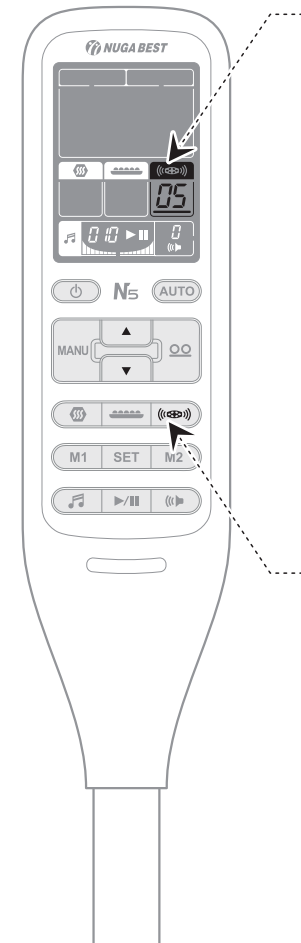

How to Use the Controller

- How to Use the external projector



Operations

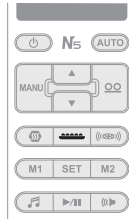

- Press the external projector button ().
- Check out the connecting conditions of the external projector (In case there is no proper connection, '- ' will show on the display)
 - Press the external projector button once: Select
 - Press and hold: On/Off (It automatically turns off after 8 hours.)

Temperature control

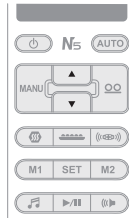

- Press the external projector () button and adjust the temperature by pressing ▲ or ▼. (Moderate temperature: 55~60°C)
- The temperature increases until it reaches the set temperature.
 - Temperature setting unit 40~70°C: Temperature setting per 1°C

Applying to the specific area

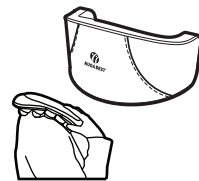

- Apply to the desired area.
- Put the external projector cover on before applying it.

Caution

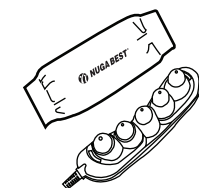

- Ensure the external projector cover to be covered while the external projector is being used.
- Be aware that any direct contact from the external projector to the skin during the high temperature setting might cause burns.

* The method of using the abdominal heating pad is the same as that of the external heating element.

How to Use the Controller

- Preheating function

Preheating function

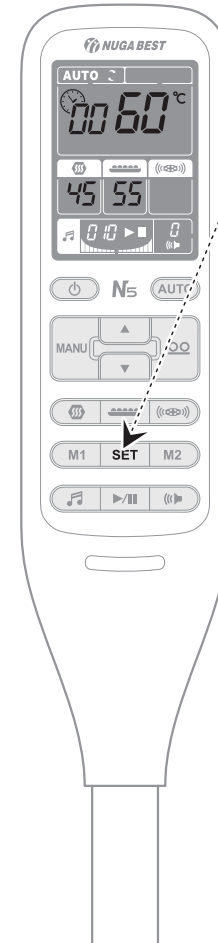

- Press SET button and hold it for a little while, the clock icon blinks and preheating mode is started. It increases the temperature until the internal projector reaches 60°C and auxiliary heating part reaches 45°C. (As the external projector(or Abdomen heating pad) is connected, it becomes preheated up to 60°C)

How to Use the Controller

- Sleep music

Play music

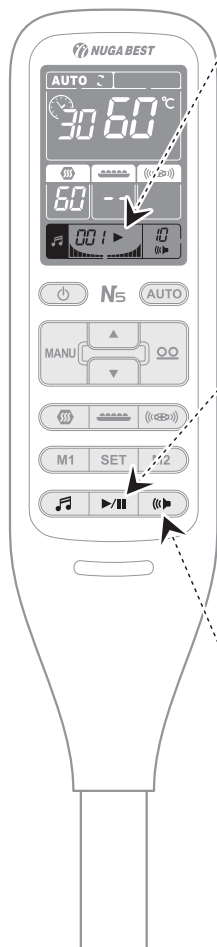

Operations

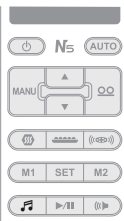

- 1 Press the music (🎵) button and hold to turn on.
 - When it's off, the number of songs that can be played is shown.
 - Press the music button: change the song
 - Press and hold: On/Off

Play music

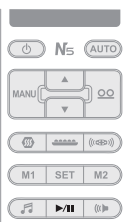

- 2 Press the Play/Pause button (▶/⏸) to play it in sequence.
 - Press again to pause
 - Pressing the button and hold it for a while causes current song to be constantly repeated.

Volume control

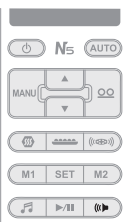

- 3 Press volume control (🔊) button to increase the volume up to level 10. (Pressing the button after level 10 lowers the volume to level 1.)
 - Press briefly to increase by one level.
 - Press and hold to decrease by one level.

Song change

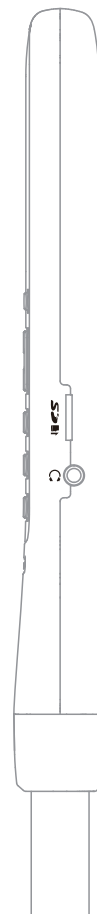

Changing the songs

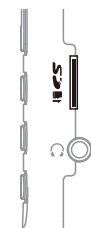

- 1 Press the mini SD card on the side of the controller with your nail to release it.
 - Using a card reader, choose any of the songs on your PC. (supports MP3 only)
 - Input the card to play the music.

Using earphones

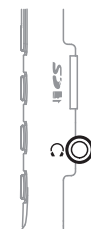

- 1 You can use earphones so as to not disturb others with the music.
 - The sound volume will vary depending on the music file, so be careful.

How to Use the Product

Basic use

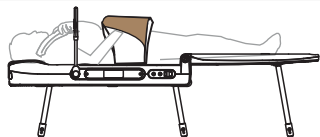

- ① Lie down with your head facing the main body and your legs facing the auxiliary body.
- ② Apply massage to your desired area such as your arms with the external projector (or Abdomen heating pad) during the Auto mode.

How to use while sitting

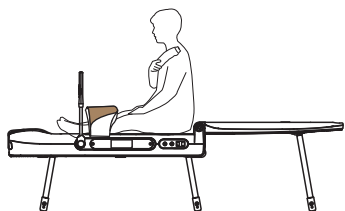

- ① Apply massage with the external projector (or Abdomen heating pad) after operating the product in the same way as the basic use.
- ② Stop the operation of the device and adjust the temperature of the auxiliary heating part before use.



Caution

Ensure using the projector cover while applying the external projector.
Be aware of burns if the product is applied to a part in the human body for a long time.
Apply the proper temperature while using the auxiliary heating part.

Simultaneous use for 2 persons

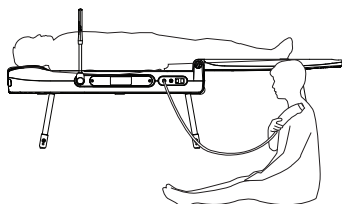

- ① Two persons can use the product simultaneously with one person on the product and another person with the external projector (or Abdomen heating pad) while sitting.



Caution

Ensure using the external projector cover while applying the external projector.
Be aware of burns if the product is applied to a part in the human body for a long time.

How to apply to the abdominal area

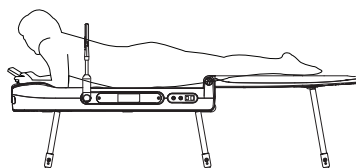

Main assembly heating

- ① Lie on your abdomen with your head facing the main body and your legs facing the auxiliary heating part.
- ② Press the button with the controller to move the internal projector to the abdominal area. Lie down your face after moving it to the abdominal area.



Caution

Do not apply the product to the chest part but only to the abdominal part manually during massage to the abdominal area.
Otherwise, it might cause damage to the human body.

N5

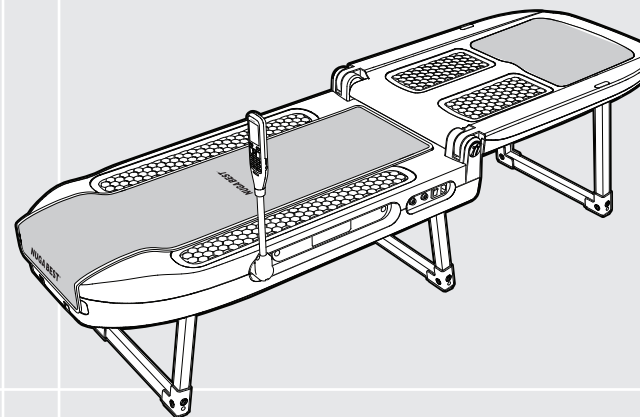

Product Storage and Care

How to Store and Clean the Product after Use	34
Check Indicator Window of Controller	35
How to Take Emergency Actions during Use	36
Self-check Items	37
Before any A/S Request	38
Product Specifications	39

How to Store and Clean the Product after Use

i Introduction

1. Separate the power cord while the product is not in use for a long time.
2. Be aware of the following for the storage place.
 - ① Keep the product in a place with no water.
 - ② Keep the product in a place with no concern of any adverse effect such as the air pressure, temperature, humidity, ventilation, sunlight and/or air containing dust, salt, sulfur, etc.
 - ③ Be careful of safety conditions such as the slope, vibration, shock, etc. (including those during transportation).
 - ④ Do not keep the product in a place near any chemical or gas.
 - ⑤ Avoid any direct sunlight during the storage.
3. Store the product after cleaning the components.

Environmental conditions

- During operation : Temperature (0~35℃), humidity (20~80%)
- Transport and storage conditions : Temperature (-25~70℃), humidity (20~80%), atmospheric pressure (700hPa to 1060hPa)

How to clean

⚠ Caution

Ensure unplugging of the power plug before cleaning. Otherwise, it might cause electric shocks.

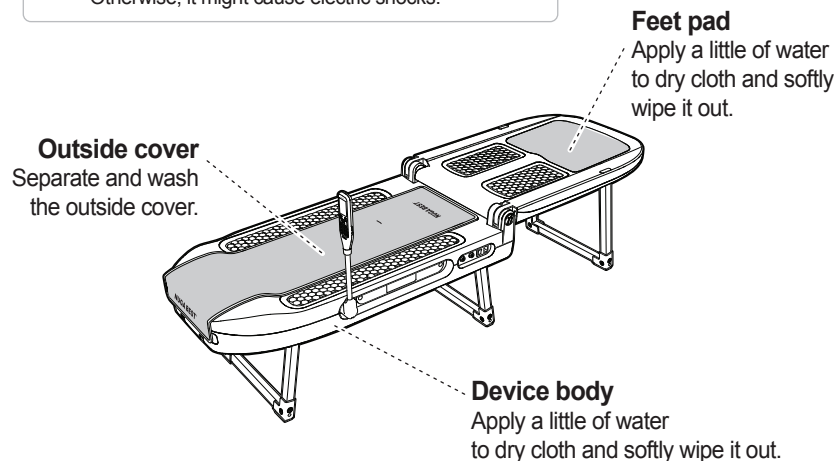

Check Indicator Window of Controller

⚠ Caution

Do not disassemble the product arbitrarily if any error occurs, but remove the power plug, turn off the power switch, and then contact your supplier. If you disassemble the product arbitrarily, it might cause serious injuries and/or damage to the product.

Display	Error code			
<p>Internal Projector</p>	E0	Lumbar vertebrae :Abnormal temperature sensor	E5	Cervical vertebrae :Heater bar disconnection
	E1	Lumbar vertebrae :Heater bar disconnection	E6	Overheating of the internal projector
	E2	Thoracic vertebrae :Abnormal temperature sensor	E7	Abnormal Limit sensor
	E3	Thoracic vertebrae :Heater bar disconnection	E8	Abnormal Motor
	E4	Cervical vertebrae :Abnormal temperature sensor	E9	Abnormal Controller communication
<p>Auxiliary heating part</p>	E0	Abnormal temperature sensor behavior in the main heating part		
	E1	Disconnection in the main heating part		
	E2	Abnormal temperature sensor behavior in the lower heating part		
	E3	Disconnection in the lower heating part		
	E6	Overheating of the element		
	<p>External projector (Abdomen heating pad)</p>	--	Disconnection in the temperature sensor of the external projector (not connected)	
E0		Abnormal temperature sensor behavior of the external projector		
E1		Disconnection in the lamp of the external projector		
E6		Overheating of the external projector		

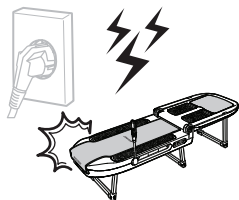

Stop using the product immediately and remove the power plug if there is any lightning.

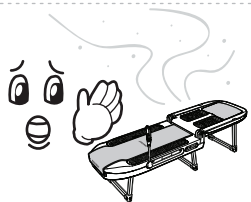

Stop using the product immediately and contact your supplier branch or our company if you smell any burn or detect any smoke from the product.



Stop using the product immediately and consult with a doctor if any abnormality occurs from the human body.

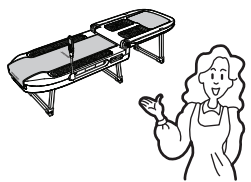

Turn off the power switch immediately, stop using the product and contact our company if you find out any failure or power failure from the product.

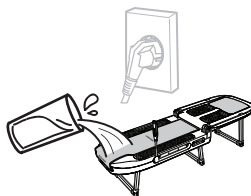

Turn off the power switch, remove the power plug immediately, and then contact our company if you have poured water into the product.



Caution

There might be risk of injuries or fire if you fail to check out the following. Make sure that you check out the following.

Check before use

1. Is the power cord connected to an outlet? Yes No
2. Is the controller operating well? Yes No
3. Is the temperature indication displayed on the temperature indicator window on the controller? Yes No
4. Is the temperature of the projector not too high? Yes No
5. Is the temperature of the auxiliary heating part not too high? Yes No
6. Is the power supply for both the internal and external projectors turned on? Yes No
7. Did you check out conditions for any damage to the power cord or cable conditions? Yes No

Check after use

1. Is the controller power turned off? Yes No
2. Is the power lamp on the projector turned off? Yes No
3. Is the power switch turned off to the point? Yes No
4. Is the power cord separated from the outlet? Yes No



Caution

Ensure checking out the following before applying for A/S if any abnormality occurs from the product.
The product might fail to operate normally even without any failure if you use it with no right understanding on how to use it.

Checklist for any abnormality on the controller

If various indicator lamps on the controller are not operating;	<ol style="list-style-type: none"> ① Turn on the main power switch. ② Check out if the power cord is accurately connected. ③ Check out if the fuse inside the main power switch is disconnected. ④ Please check the error code on the controller.
In case of a warning message with error codes, E1, E3 or E5, for the internal projector, is displayed	<p>This warning message is shown when the heater bar of internal heating element is not functioning properly. In this case, replace the heater bar to fix the problem.</p> <p>Do not disassemble the product but contact your nearest supplier or A/S center.</p>
In case of a warning message with the error code, E1, for the external projector (Abdomen heating pad), is displayed	<p>It is a safety message due to failure in the heating lamp for the external projector (Abdomen heating pad).</p> <p>The product will operate if you replace the heating lamp. Do not disassemble the product but contact your nearest supplier or A/S center.</p>

Checklist for any abnormality on the internal projector

If the internal projector is not operating;	<ol style="list-style-type: none"> ① Check out if the power cord is accurately connected. ② Check the error code on the controller display. <p>Do not disassemble the product but contact your nearest supplier or A/S center.</p>
---	--

Checklist for operations of the low frequency pad

If the low frequency pad is not operating;	Check out if the low frequency connector is connected accurately.
--	---

Product name and model name	Thermal massager N5
Manufacturer	<p>NUGA MEDICAL CO., LTD. 185, Jiraeul-ro, Jijeong-myeon, Wonju-si, Gangwon-do, Korea</p>
Date of manufacture / number of manufacture	Marked on the product
Product weight	50.5 kg (± 0.5 kg)
Product size	1925 X 580 X 516 (mm)
Cautions during use	Refer to User Manual
Operating method	Refer to User Manual
Electric rating	AC 220-240 V~, 50-60 Hz
Power consumption	370 W

Memo

Product Warranty

	Product name	
	Model name	
Company	Warranty period	1 year from purchase
	Date of purchase	
	Place of purchase	
	Phone	
Customer	Name of customer	
	Customer number	
	Address	

※ Please keep this warranty carefully. You can receive sufficient service only by presenting this warranty with the place and the date of purchase.

- NUGA Medical Co., Ltd. provides warranty of this product according to the regulations of the Consumer Protection Act.
- Contact your local sales retailer or NUGA Medical office when the product is damaged.
- The spare parts of this product are secured for 3 years after this product is discontinued.
- You must have the place of purchase written in the warranty at the time of your purchase in order to receive warranty repairs.

1. The warranty is valid until 1 year from the date of purchase and only damages caused during normal operation are subject for warranty repairs.
2. The warranty period of this product is calculated from the date of purchase, and therefore have the store of purchase record the date of purchase on your warranty when you purchase the product (When the date of purchase cannot be verified, the warranty period is added from the day after 6 months from the date of manufacture).
3. When this product is used for commercial purposes (e.g., used for sales, in abnormal environment, etc.) or for industrial purposes, the warranty period is reduced to 6 months. (including essential spare parts)
4. This warranty cannot be reissued.

※ Warranty repair is not provided in the following cases.

- When damage is caused by natural disasters (e.g., fire, earthquake, flood, and wind)
- When replacing consumptive parts that normally wear from use
- When damage is caused by an abnormal power source or faults in a connecting unit.
- Other external reasons other than faults of the product itself.
- When damage is caused by repairs or modifications done by a person who is not a certified repair personnel of NUGA Medical's local office or service center.

NUGA MEDICAL CO., LTD.
http://www.nuga.kr

